

The Winning Force

DURMA

▶ **PL-C** SERIES
Plasma Cutting



- Strong
- Precise
- Efficient
- Fast
- High Repeatability



DURMA The Winning Force



As a total supplier for sheet metal manufacturing with almost 60 years of experience, Durma understands and recognizes the challenges, requirements and expectations of the industry. We strive to satisfy the ever higher demands of our customers by continuously improving our products and processes while researching and implementing the latest technologies.

In our three production plants with a total of 150.000 m², we dedicate 1,000 employees to delivering high quality manufacturing solutions at the best performance-to-price ratio in the market.

From the innovations developed at our Research & Development Center to the technical support given by our worldwide distributors, we all have one common mission: to be your preferred partner.

Present Durmazlar machines with **DURMA** name to the world.



	1 High technology, modern production lines	
2 Top quality components		3 High quality machines designed in R&D Centre

PL-C Plasma Cutting Series

Durma has redefined its plasma cutting technology with PL-C series. The PL-C series is manufactured as a true precision tool for plasma cutting. These high performance plasma machines are designed to cut a wide range of mild steel, stainless steel and aluminum.

Perfectly equipped for precise cuts

Precise Cutting

High Durability

Energy Efficiency

Low energy consumption

Why DURMA Plasma Cutting Machines

- Better and faster and more precise cuts
- Rigid body structure
- Long Durability
- Hi-tech equipment
- AURORA Plasma Software
- Reliable brand



A plasma that you can count on

“Reliability and Durability” that what makes a DURMA plasma

PLC Plasma cutting machines are reliable source of plasma cuttings when it comes to higher level of material thickness. Hyperterm cutting head and AURORA plasma software ensure precise and quality cuts. AURORA enables users to enhance plasma with extensive specifications and capabilities. Depending on material and thickness, cut quality and cutting speed we can offer you the appropriate solutions for your tasks.



General Specifications

- Sensitive, precise Hyperterm cutting head
- DURMA designed and copyrighted AURORA control unit
- Hyperterm power supply options for different sheet thicknesses
- Rigid body structure with long durability and high performance
- Electrical Panel and Durma Filter that creates safer working environment
- Sensitive solutions at high material thickness
- Variety of dimension models can be made according to the size of material to be cut
- CE Norm Safety Standards (Wire)
- Environment friendly, every efficient and eye-pleasing AURORA software

PLC Series Standard Equipment

Steel Construction

Strengthened steel body structure increases DURMA plasma's durability and performance.



Hyperterm Cutting Head

Hyperterm cutting head is designed for fast cutting speeds, long life and superior cut quality for high productivity and low operating costs. Hyperterm delivers superior HyPerformance cutting across a broad range of application needs, from very thin to heavier thickness.



Durma CNC Control Unit

PLC series come with standard DURMA CNC control unit that provides convenient user experience. Users can realize tasks on plasma efficiently with a user-friendly control unit.



Hyperterm Power Source

Hyperterm combines fast cutting speeds, rapid process cycling, quick changeovers and high reliability to maximize productivity. Key advantages are new HDi thin stainless steel technology, superior cut quality and consistency, maximized productivity, minimized operating cost and unmatched reliability.



PLC Series Optional Equipment

Bevel Cutting

Precision and accuracy are two important elements that define Durma Bevel cutting device. It allows users to cut up to 45 degrees angle and automatically controls torch height to prevent disturbances and collisions.

Depending on power source, Bevel cut can handle up to 40 mm of material thickness.



Drilling Head

Drilling head is an optional feature that is designed for variety of drilling types. It can include up to four drilling head types. It can drill the plate according to program set on the software.



DURMA Filter Unit

DURMA Filter units are designed for the extraction and filtration of dust, fume and emissions generated during CNC Plasma cutting operations. Hot big particales and sparks are seperated with integrated spark sperator system. It creates better and safer working environment for Plasma operators.



Pipe Cutting

Different industrial applications can be performed with PLC series. In this matter, PLC series answer to your pipe cutting needs perfectly. Increased productivity and accuracy can be achieved with pipe cutting option on PLC series.



NEW

AURORA Plasma Cutting Software

“One single software to consondilate all of your needs...”

Let us introduce our latest development on plasma cutting technologies: **DURMA** has realized **AURORA** that will answer to your cutting needs. Durma ensures convinience for its user with AURORA that consondilates all of your cutting needs with a single software.

Durma named this software AURORA because it has a eye-pleasing interface and it is very user-friendly. Aurora is applicable to variety of industrial applications such as **plasma cutting, oxi cutting, bevel cutting, pipe cutting, drilling, tapping** and most importantly **true hole technology**.

We burst with pride of AURORA and we would like it to be heard by everyone. That is why it features multi-language and manual translation mode to address its users on a global scale.

AURORA is set as standard software on all DURMA plasma cutting machines and ready to operate on a 24/7 basis.



- Fast Data Entry
- Task Management
- Increased Efficiency

- Complete Service
- Increased Productivity
- User-friendly Interface
- Remote Service Mode
- Flexible Operation Ability



HYPERTHERM Plasma Power Source

“Perfect equipment for perfect results...”

DURMA plasma cutting machines are equipped with **Hypertherm** plasma systems that deliver HyDefinition cut quality at half the operating costs. It provides the most expansive process range and thickest stainless steel and aluminum cutting capacity available on the market.

Hypertherm technology delivers more consistent cut quality for longer periods of time at half operating cost. By reducing electrode and nozzle erosion, LongLife technology delivers consistent HyDefinition cut quality over the longest period of time for a significant reduction in operating cost and downtime.

Key Advantages

HDI Thin Stainless Steel Technology

Low Operating Costs

Precise and Quality Cuts

Unmatched Reliability

HyDefinition Technology

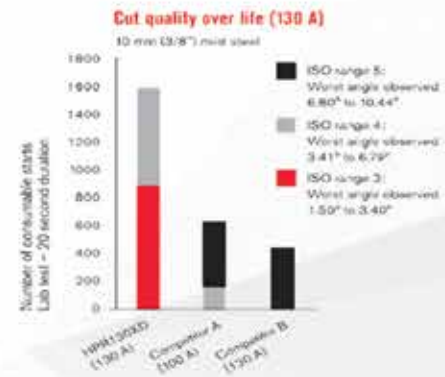

True Hole Technology

Hypertherm's patent-pending True Hole cutting technology for mild steel produces significantly better hole quality than what has been previously possible using plasma. This is delivered automatically without operator intervention, to produce unmatched hole quality that surpasses the competition.



With True Hole technology cut with HPRXD Plasma

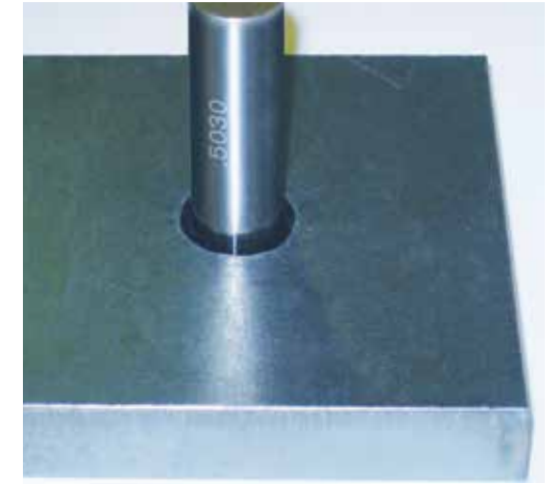

Without True Hole technology cut with HPRXD Plasma

Cross section of a hole

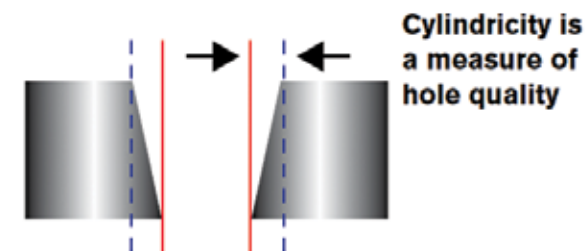

Hypertherm's True Hole cutting technology for mild steel is exclusively available for use on Hypertherm's HPRXD auto gas plasma systems and is automatically applied by our cutting optimization and nesting software and CNC software to holes up to 1" with hole diameter to thickness ratios as low as 1:1.

True Hole technology is a specific combination of the following parameters that is linked to a given amperage, material type, material thickness and hole size:

- Process gas type
- Gas flow
- Amperage
- Piercing methodology
- Lead in/out technique
- Cut speed
- Timing

True Hole Technology requires a HyPerformance Plasma HPRXD auto gas system along with a True Hole enabled cutting table, nesting software, CNC, and torch height control.

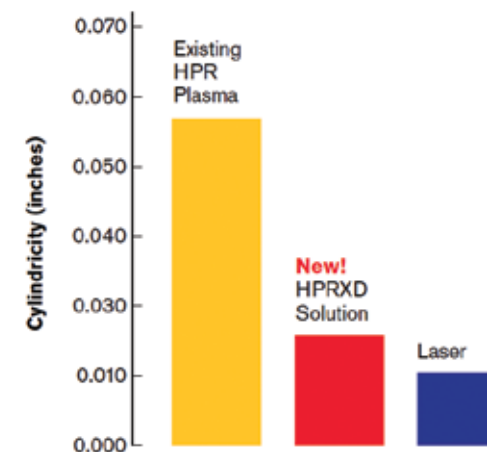

HYPERTHERM XPR 300

- Unmatched performance. Unbeatable operating cost.
- Industry leading X-Definition cut quality
- Optimized productivity and reduced operating costs
- Expanded HyDefinition technology
- Vented Water Injection (VWI)
- Improved torch geometry

The XPR advances HyDefinition® cut quality by blending new technology with refined processes for next generation, X-Definition cutting on mild steel, stainless steel and aluminum.

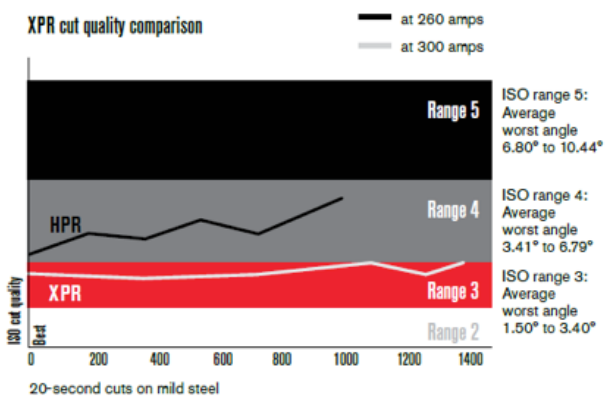

- Consistent ISO range 2 results on thin mild steel
- Extended ISO range 3 cut quality results compared with earlier plasma technology
- Superior stainless steel cut quality across all thickness ranges
- Superior results on aluminum using Vented Water Injection™ (VWI)

Long Life air and oxygen plasma:MAXPRO200

The MAXPRO200 plasma cutting system achieves impressive cut speeds, consistent cut quality and exceptional consumable life with air or oxygen plasma gas. Optimized cutting parameters are automatically set and controlled in one step for easy operation. Engineered for heavy-duty, high capacity mechanized and handheld cutting and gouging, the MAXPRO200 delivers reliable performance across a wide range of industrial applications.



Powermax125

Professional-grade plasma metal cutting and gouging system for handheld cutting 38 mm and mechanized piercing 20 mm. Finish jobs faster with cut speeds 5 times greater than oxyfuel on 12 mm mild steel. Maximize your cutting time with 100% duty cycle.



Core™ console

Unmatched mild steel cutting performance and superior angularity and edge finish on stainless steel up to 12 mm (1/2"). This is delivered through a new N2 HDi™ process that prevents the mixing of air into the plasma gas, creating an improved, brighter edge finish.



Vented Water Injection™ (VWI) konsolu

All Core console capabilities plus a more than 10% increase in piercing thickness with argon-assist. Significantly enhanced stainless steel and aluminum capabilities are delivered with the addition of F5 HDi processes and patent pending Vented Water Injection (VWI).



OptiMix™ console

All the capabilities of the Core and VWI consoles plus discrete 3-gas mixing – Ar, H2, and N2 – for the world's most flexible, premium stainless steel and aluminum cutting capability.



		Powermax 45 XP	Powermax 65	Powermax 85	Powermax 105	Powermax 125
Capacity	Mild steel	Production (Pierce)* Severance	12 mm (1/2")	16 mm (6/8") 32 mm (1-1/4")	20 mm (3/4") 38 mm (1-1/2")	22 mm (7/8") 50 mm (2") 57 mm (2-1/4")
	Stainless steel	Production (Pierce)*	12 mm (1/2")	12 mm (1/2")	16 mm (6/8")	20 mm (3/4") 25 mm (1")
	Aluminum	Production (Pierce)*	10 mm (3/8")	12 mm (1/2")	16 mm (6/8")	20 mm (3/4") 25 mm (1")
Speed			12 mm (1/2") 540 mm/mm (18 lpm)	12 mm (1/2") 840 mm/mm (30 lpm)	12 mm (1/2") 1280 mm/m (45 lpm)	12 mm (1/2") 1690 mm/m (62 lpm) 2050 mm/m (75 lpm)
Cut angle	ISO 9013 range**	5	5	5	5	5
Weldability		Preparation required	Preparation required	Preparation required	Preparation required	Preparation required
Process gases by material (plasma/shield)	Mild steel	Air	Air	Air	Air	Air
	Stainless steel	Air, N ₂ , f5	Air, N ₂ , f5	Air, N ₂ , f5	Air, N ₂ , f5	Air, N ₂ , f5
	Aluminum	Air, N ₂	Air, N ₂	Air, N ₂	Air, N ₂	Air, N ₂
Process amps (cutting)		10 - 45	20 - 65	25 - 85	30 - 105	30 - 125

CNC Control Unit

Durmazlar uses own plasma software called Aurora on Beckoff CP 2919 control units. Users can load cutting parameters easily. Also users can call preloaded simple shapes from the library and can add more new shapes to the library. The cutting process can be seen on the screen during cutting.

The Control Panel can be connected to another computer or LAN by Ethernet Connection Point.

The machine automatically searches the plate, machine finds the zero point and calculates the angle automatically.



CAD Cam Software

Metalix software is available for easy programming and drawing of parts. It also easily and quickly converts DXF and DWG files to machine language for cutting.

The automatic nesting feature looks at the multiple parts to be cut from the sheet, and then organizes them on the sheet in the most efficient way. Lower material costs.

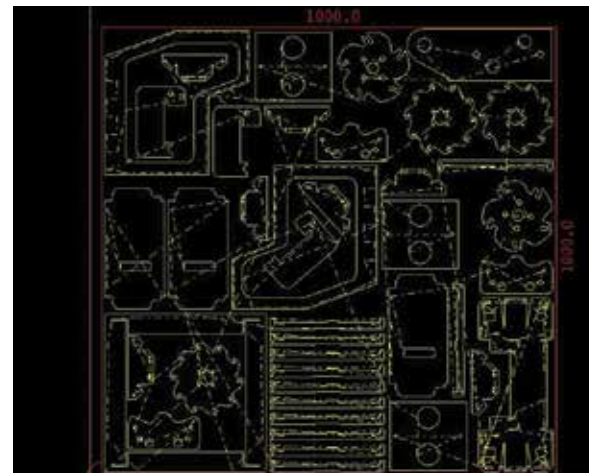

Torch Height Control

Durma Torch Height Control System is designed for Plasma Cutting Machines such as cutting process on X-Y tables. System sets cutting height automatically between Torch and Working Part by using ark voltage.

Breakaway System protects the Torch via stopping the system if there is any error on system occurs crashes.

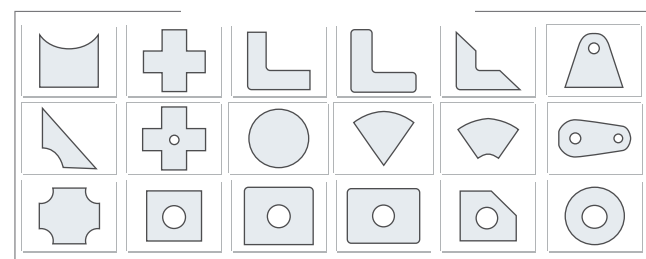

Fume Extraction System

It is designed for filtration of released smoke and dust in the plasma cutting applications

Panel filters produced with non-woven polyester and covered with PTFE membrane. Panel filters 0.2-2 micron range particles are capable of filtering efficiency of 99.9%. It filtrates; According to DIN EN 60335 standard it is Class: M and According to DIN EN 1822 standard it is Class: H13. Average filter life is 20,000 operating hours. There is dust bucket. Easy Strippers are fully sealed wheel-mounted. Dust bucket volume is 80 lt.

Low noise level with advanced silencer structure <70dB(A)

All connection pipes between Plasma Machine and Filter galvanized. Galvanised pipes minimizes losses.

Type	Capacity (m3/h)	Motor (kW)	Fan Pressure (Pa)	Filter Surface (m2)	Filter Number	A (mm)	B (mm)	H (mm)	ØD (mm)	X (mm)	Y (mm)	Weight (kg)
PL-6000	6000	7.5	2950	95	10	2384	1514	2190	350	901	1419	795
PL-8000	8000	7,5	2300	133	14	3004	1514	2190	400	901	1419	925
PL-10000	10000	11	2600	152	16	3382	1514	2190	450	901	1419	1160

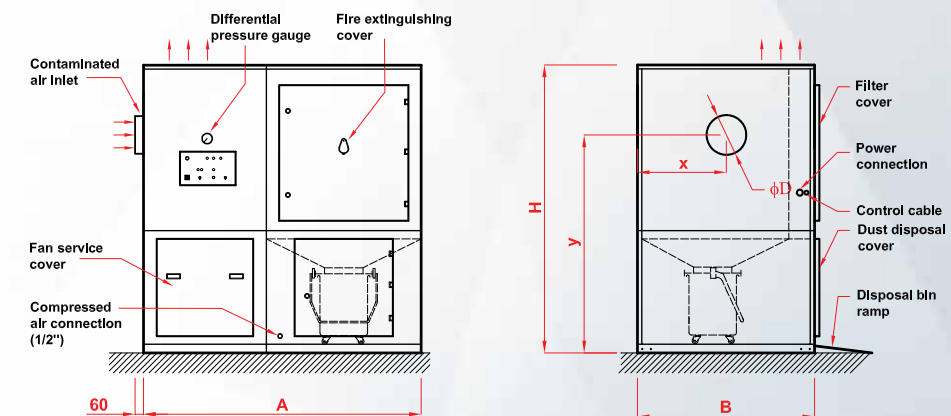

Long life cartridge

Easy filter maintenance





Multi Drilling Head

Durma multi drilling systems are designed as mass production-oriented. The existence of 4 and 6 options is available and HSK-63 series are used with tool holders which have high precision.



Bevelling Head

Durma 5-axis Plasma Angled Cutting Unit special designed for respond to multiple angled cuttings.

Durma 5-axis Cutting can be done by providing a 45 degrees angle by angle cutting unit and quickly switch between different angles it allows you to smooth contours.



Single Drilling Head

Durma single drilling systems are designed with a compact structure. M16 tapping; it has the capacity of drilling up to $\text{Ø}20$

Pipe Cutting

Durma pipe-profile cutting unit has been specially designed to cut the tubes and profiles of different sizes.

Max Speed	mmpm	2500
Minimum Pipe Diameter	mm	Ø50
Maximum Pipe Diameter	mm	Ø400
Maximum Profile Size	mm	250x250
Maximum Pipe-Profile Length	mm	6000mm
Maximum Pipe-Profile Weight	kg	1150 kg
Mirror Mechanism: 4 Clamp, Manual Crimping		

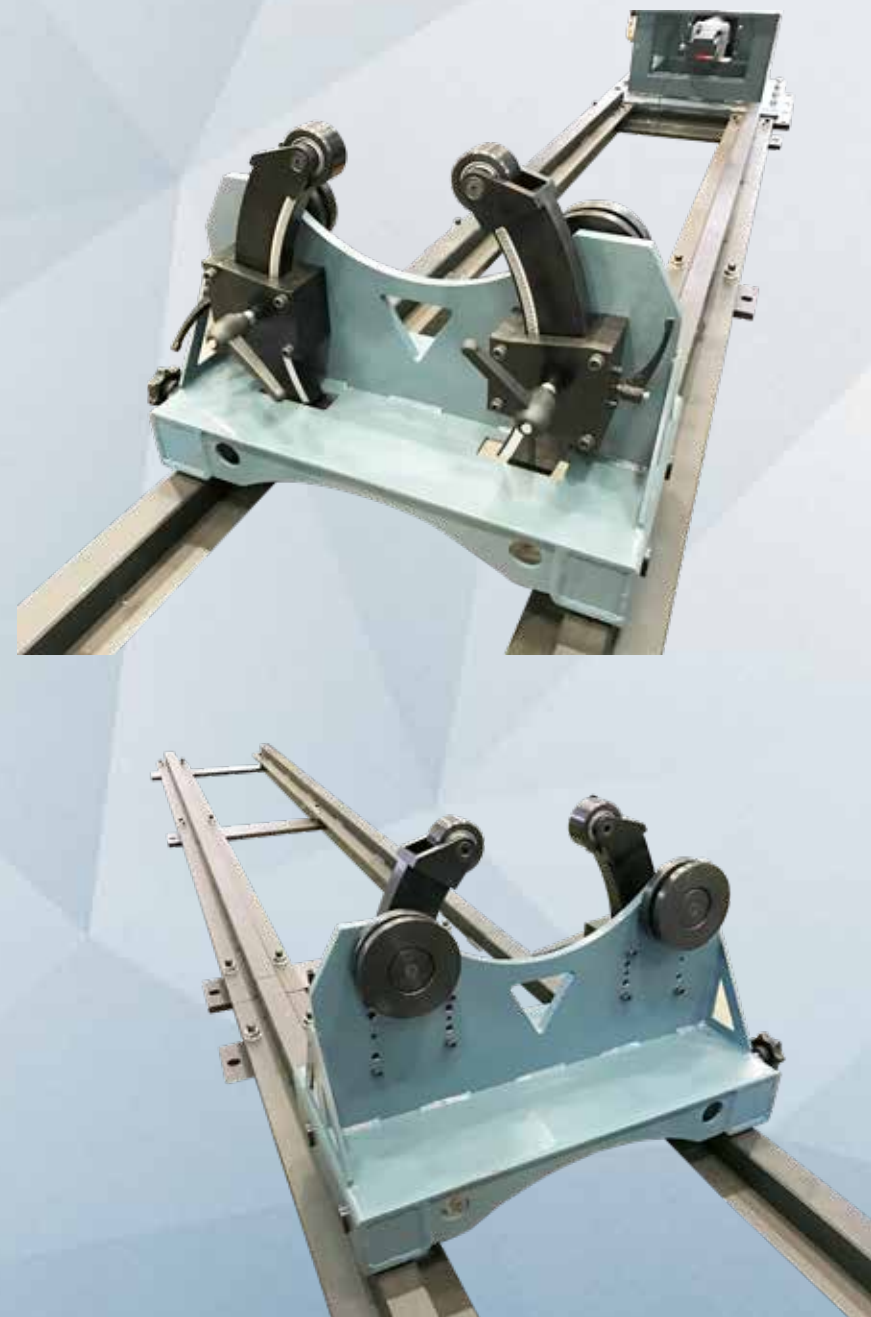

Cutting Tables

Patented Durma modular tables contains on a lot of advantages, such as high-precision cutting quality and easy installation.

Durma plazma cutting machine tables are with high engineering design devided, section by section in a horizontal and vertical way to achive the maximum efficiency of the filter.

Cover on the cut section are controlled by pneumatic valves.

Easy Installation

High Sensitivity

Easy Cleaning



OXY Cut

Durma CNC controlled cutting oxygen provides 120 mm cutting opportunity.

There is 45-degree angle cutting manual option in A axis and B axis.

In terms of special applications, cutting thickness of 200 mm can be done easily.



HPR Specifications

HPR Specifications	Birim	HPR130XD	HPR400XD	XPR 300
Plasma Power Source		Hypertherm	Hypertherm	Hypertherm
Max. High Quality Cutting Capacity (MS) (Edge Start)	mm	38	80	80
Max. High Quality Cutting Capacity (MS) (Pierce Capacity)	mm	16	50	50
Max. Positioning Speed X / Y	m/dk.	35	35	35
Max. Cutting Speed	m/dk.	12	12	12
Positioning Accuracy	mm	+/-0.1	+/-0.1	+/-0.1
Repeatability	mm	0.1	0.1	0.1
Output Current	A	130	400	300
Current Regulation Range	A	30 - 130	30 - 400	30 - 300
Gas Console	-	O ₂ , N ₂ , H35,F5 hava	O ₂ , N ₂ ,H35,F5, Hava	--
Cutting Angle	derece	2 - 4	2 - 4	2 - 4
Plasma Gas	-	O ₂ , N ₂ , H35,F5 hava	O ₂ , N ₂ ,H35,F5, Hava	N ₂ , F5, Ar, H35, O2, Hava
Plasma Shield Gas	-	O ₂ , N ₂ , Hava, H35	O ₂ , N ₂ , Hava, H35	--

Air Dryer

Air is used as the Auxiliary Gas or Cutting Gas in the plasma system. The used air should be clean, dry and lean. Therefore, the user should always keep air dryer in the system.

- 3° C pressure dew point.
- Very low pressure losses.
- Suitable design for tropical climates.
- R-134a refrigerant gas and designed large concentrator gives a maximum of 60° C inlet temperature and ability to work in a nominal capacity at ambient temperatures.
- Compact design.
- Standard digital controller capable of-failure warning notices and offering energy-saving features.



PL-C Machine Layout

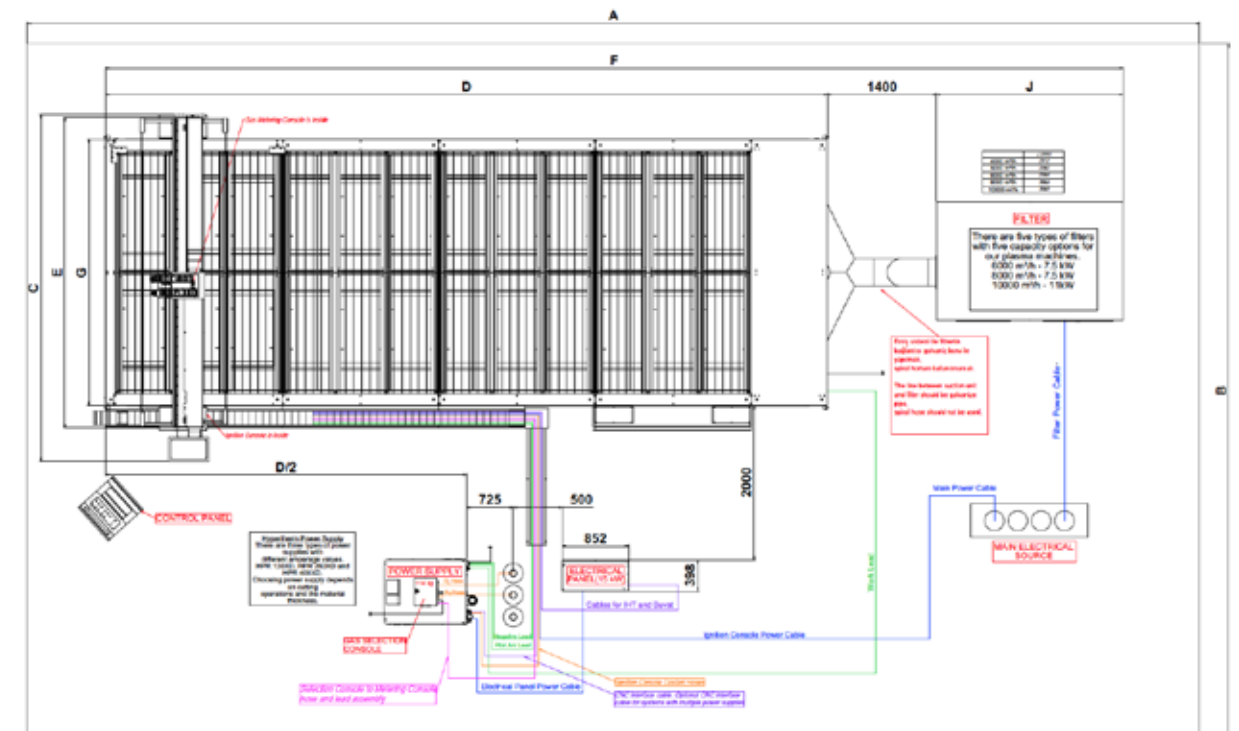

Longer Consumable Life

With long-life technology patent, we provide long consumable life for materials by using the world class equipments and control systems. The wide range of cutting options with the high cutting speeds on same materials are applied. High performance materials are designed to provide quality cuts with lower costs.

Standard & Optional Equipment

Standard Equipment

Welded Steel Construction

- DURMA CNC Control Unit (AURORA)
- Remote Control Diagnostic (Ethernet)
- Lantek Software W/Autonesting
- Cutting Plate Alignment by Laser
- DURMA Torch Height Control
- Two Side Motion Control System (Rack & Pinion)
- AC Servomotors for X & Y axes motion
- CNC control outputs/inputs for filter unit
- Consumables starting kit
- Plasma Torch*
- Ignition Console*

*If Power source is selected

Optional Equipment

- Hypertherm Powermax 125
- Hypertherm Max Pro 200
- Hypertherm HPR 130 XD
- Hypertherm HPR 400 XD
- Hypertherm XPR 300
- Auto Gas Console for Hypertherm XD Series
- Manual Gas Console for Hypertherm XD Series
- Core Gas Console for Hypertherm XPR 300
- VWI Gas Console for Hypertherm XPR 300
- Optimix Gas Console for Hypertherm XPR 300
- CE Norm Safety Wire
- Oxy-fuel Torch
- Plasma Torch Brake System
- Man. Plasma Beveling Head (+/- 45)
- Cnc. Plasma Beveling Head (+/- 45)
- Single Drilling Head
- 4 - 6 Drilling Heads
- Filter for 130A
- Filter for 260A
- Filter for 400A
- Air Dryer
- Tube Cutting Device Ø50 mm - Ø400 mm
- Additional Support for Tube cutting device
- Fault and Program end signal lamp

Fast on Service and Spare Parts

DURMA provides the best level of service and spare parts with qualified personnel and spare parts in stock. Our experienced and professional service personnel are always ready at your service. Our professional training and application enriched courses will give you an advantage to use our machinery.



Consultancy



Spare Parts



R&D Center



After Sales Service



Service Agreements



Software



Training



Flexible Solution



PANEL BENDER



PUNCH



PRESS BRAKE



VARIABLE RAKE SHEAR



PLASMA



L ANGLE PROCESSING CENTER



TUBE LASER CUTTING

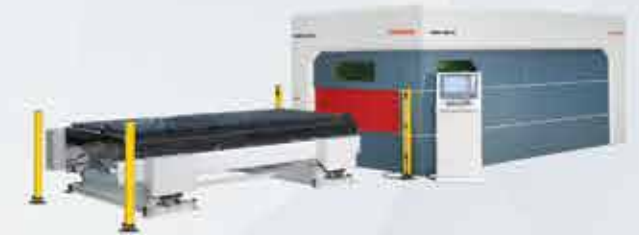

FIBER LASER



IRON WORKER



POWER OPERATED SHEAR



ROLL BENDING



PROFILE BENDING



CORNER NOTCHER

DURMA

Today, Tomorrow, Forever...

PL-C SERIES
Plasma Cutting

Durmazlar Makina San. ve Tic. A.Ş.
OSB 75. Yıl Bulvarı Nilüfer-Bursa / Türkiye
P: +90 224 219 18 00
F: +90 224 242 75 80
info@durmazlar.com.tr

www.durmazlar.com.tr



Durmazlar Makina San. Tic. A.Ş. has right to change catalogue values and machine technical details without notice.